



**Technical and Test Institute
for Construction Prague**
Prosecká 811/76a
190 00 Prague
Czech Republic
eota@tzus.cz



Member of



www.eota.eu

European Technical Assessment

ETA 20/0108 of 30/01/2020

(English language translation, the original version in Czech language)

Technical Assessment Body issuing the ETA: Technical and Test Institute
for Construction Prague

Trade name of the construction product

Friulsider Injection System KEM HP
KEM HP Blue
KEM HP Tropical
KEM HP Express

**Product family to which the
construction product belongs**

Product area code: 33
Bonded injection type anchor for use in
uncracked concrete

Manufacturer

Friulsider S.p.A.
Via Trieste, 1
33048 san Giovanni al Natisone (Ud)
Italy

Manufacturing plant(s)

Friulsider S.p.A., Plant 1 Germany

**This European Technical Assessment
contains**

15 pages including 12 Annexes which form
an integral part of this assessment.

**This European Technical Assessment is
issued in accordance with regulation
(EU) No 305/2011, on the basis of**

EAD 330499-01-0601

Translations of this European Technical Assessment in other languages shall fully correspond to the original issued document and should be identified as such.

Communication of this European Technical Assessment, including transmission by electronic means, shall be in full (excepted the confidential Annex(es) referred to above). However, partial reproduction may be made, with the written consent of the issuing Technical Assessment Body - Technical and Test Institute for Construction Prague. Any partial reproduction has to be identified as such.

1. Technical description of the product

The Friulsider Injection System KEM HP, KEM HP Blue, KEM HP Tropical and KEM HP Express for uncracked concrete is a bonded anchor consisting of a cartridge with injection mortar and a steel element. The steel elements consists of a commercial threaded rods, a hexagon nut and a washer. The steel elements are made of galvanized steel or stainless steel.

The steel element is placed into a drilled hole filled with injection mortar and is anchored via the bond between metal part, injection mortar and concrete.

The illustration and the description of the product are given in Annex A.

2. Specification of the intended use in accordance with the applicable EAD

The performances given in Section 3 are only valid if the anchor is used in compliance with the specifications and conditions given in Annex B.

The provisions made in this European Technical Assessment are based on an assumed working life of the anchor of 50 years. The indications given on the working life cannot be interpreted as a guarantee given by the producer, but are to be regarded only as a means for choosing the products in relation to the expected economically reasonable working life of the works.

3. Performance of the product and references to the methods used for its assessment

3.1 Mechanical resistance and stability (BWR 1)

Essential characteristic	Performance
Characteristic resistance to tension load (static and quasi-static loading)	Annex C1, C2
Characteristic resistance to shear load (static and quasi-static loading)	Annex C1, C3
Displacements under short term and long term loading	Annex C4
Durability	Annex B1
Characteristic resistance and displacements for seismic performance categories C1 and C2	NPA

3.2 Hygiene, health and environment (BWR 3)

No performance determined.

3.3 General aspects relating to fitness for use

Durability and serviceability are only ensured if the specifications of intended use according to Annex B1 are kept.

4. Assessment and verification of constancy of performance (AVCP) system applied with reference to its legal base

According to the Decision 96/582/EC of the European Commission¹ the system of assessment verification of constancy of performance (see Annex V to Regulation (EU) No 305/2011) given in the following table applies.

Product	Intended use	Level or class	System
Metal anchors for use in concrete	For fixing and/or supporting to concrete, structural elements (which contributes to the stability of the construction works) or heavy units	-	1

¹ Official Journal of the European Communities L 254 of 08.10.1996

5. Technical details necessary for the implementation of the AVCP system, as provided in the applicable EAD

5.1 Tasks of the manufacturer

The manufacturer may only use raw materials stated in the technical documentation of this European Technical Assessment.

The factory production control shall be in accordance with the control plan which is a part of the technical documentation of this European Technical Assessment. The control plan is laid down in the context of the factory production control system operated by the manufacturer and deposited at Technický a zkušební ústav stavební Praha, s.p.² The results of factory production control shall be recorded and evaluated in accordance with the provisions of the control plan.

5.2 Tasks of the notified bodies

The notified body shall retain the essential points of its actions referred to above and state the results obtained and conclusions drawn in a written report.

The notified certification body involved by the manufacturer shall issue an certificate of constancy of performance of the product stating the conformity with the provisions of this European Technical assessment.

In cases where the provisions of the European Technical Assessment and its control plan are no longer fulfilled the notified body shall withdraw the certificate of constancy of performance and inform Technický a zkušební ústav stavební Praha, s.p without delay.

Issued in Prague on 30.01.2020

By

Ing. Mária Schaan

Head of the Technical Assessment Body

² The control plan is a confidential part of the documentation of the European Technical Assessment, but not published together with the ETA and only handed over to the approved body involved in the procedure of AVCP.

Installation threaded rod

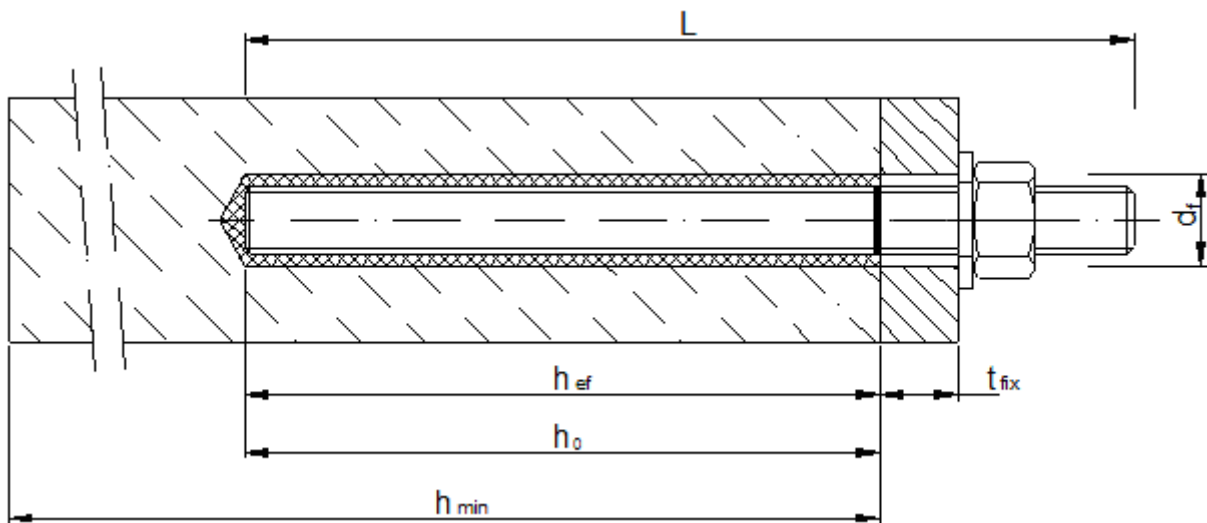

- d_f = diameter of clearance hole in the fixture
- t_{fix} = thickness of fixture
- h_{ef} = effective embedment depth
- h_0 = depth of drill hole
- h_{min} = minimum thickness of member

Friulsider Injection System for concrete
KEM HP, KEM HP Blue, KEM HP Tropical, KEM HP Express

Product description
Installed conditions

Annex A 1

Cartridge: KEM HP, KEM HP Blue, KEM HP Tropical, KEM HP Express

150 ml, 280 ml, 300 ml up to 330 ml and 380 ml up to 420 ml cartridge (Type: coaxial)

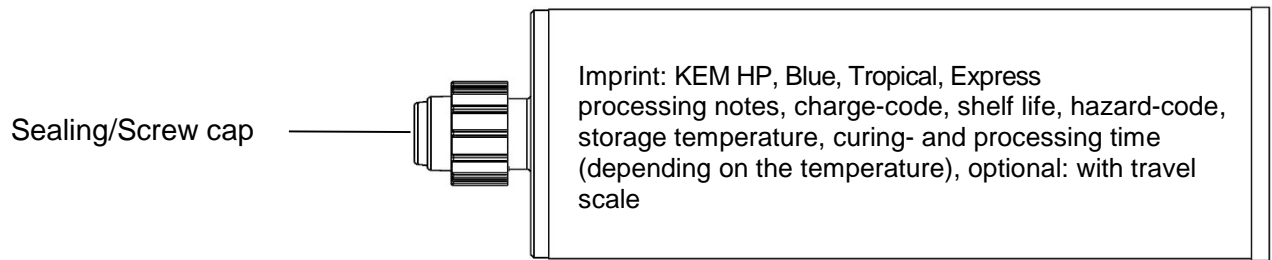

235 ml, 345 ml up to 360 ml and 825 ml cartridge (Type: “side-by-side”)

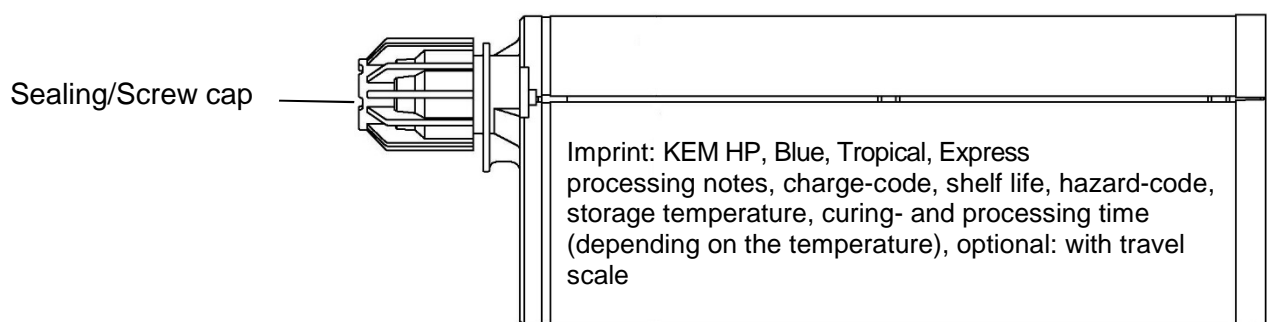

165 ml and 300 ml cartridge (Type: “foil tube”)

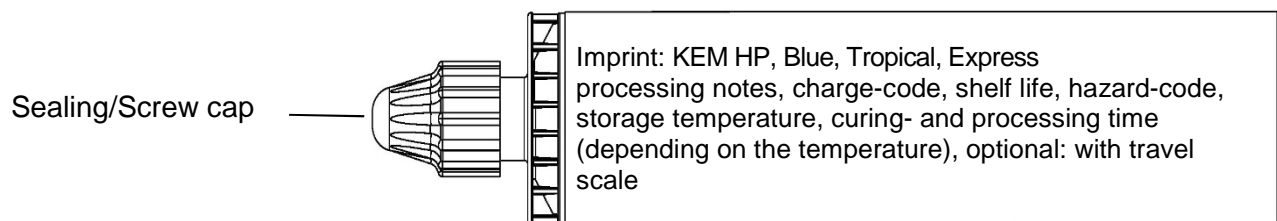

Static mixer

SM 14W



CM 8W



**Friulsider Injection System for concrete
KEM HP, KEM HP Blue, KEM HP Tropical, KEM HP Express**

Product description
Injection system

Annex A 2

Threaded rod M8, M10, M12, M16, M20, M24 with washer and hexagon nut

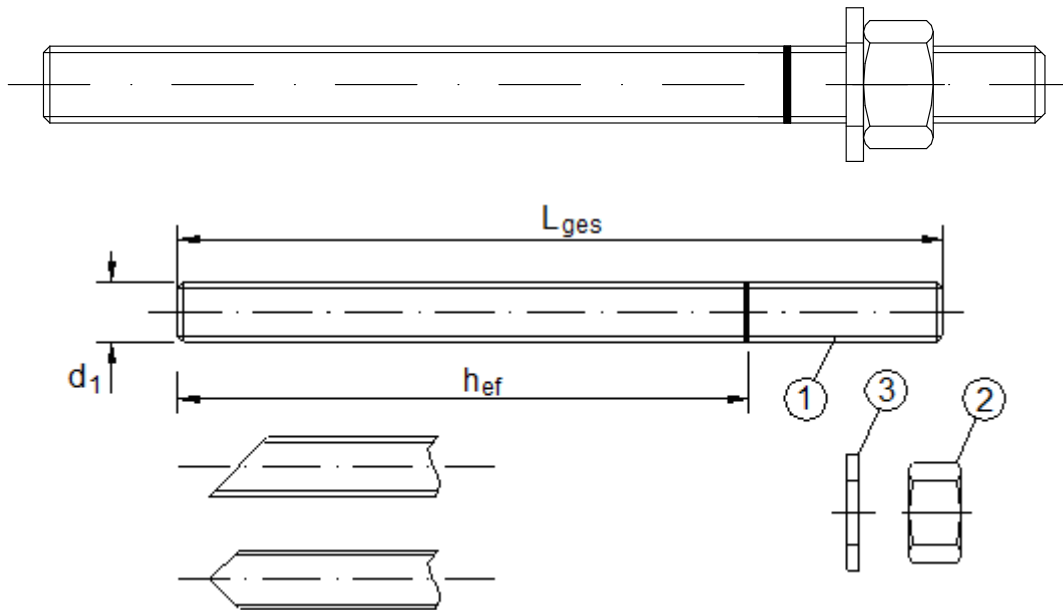

Commercial standard threaded rod with:

- Materials, dimensions and mechanical properties acc. Table A1
- Inspection certificate 3.1 acc. to EN 10204:2004
- Marking of embedment depth

Friulsider Injection System for concrete
KEM HP, KEM HP Blue, KEM HP Tropical, KEM HP Express

Product description
 Threaded rod

Annex A 3

Table A1: Materials

Part	Designation	Material	
Steel, zinc plated (Steel acc. to EN 10087:1998 or EN 10263:2001) zinc plated ≥ 5 µm acc. to EN ISO 4042:1999 or hot-dip galvanised ≥ 40 µm acc. to EN ISO 1461:2009 and EN ISO 10684:2004+AC:2009 or sherardized ≥ 40 µm acc. to EN ISO 17668:2016			
1	Anchor rod	Property class acc. to EN ISO 898-1:2013	4.6 $f_{uk}=400 \text{ N/mm}^2; f_{yk}=240 \text{ N/mm}^2; A_5 > 8\%$ fracture elongation
			4.8 $f_{uk}=400 \text{ N/mm}^2; f_{yk}=320 \text{ N/mm}^2; A_5 > 8\%$ fracture elongation
			5.6 $f_{uk}=500 \text{ N/mm}^2; f_{yk}=300 \text{ N/mm}^2; A_5 > 8\%$ fracture elongation
			5.8 $f_{uk}=500 \text{ N/mm}^2; f_{yk}=400 \text{ N/mm}^2; A_5 > 8\%$ fracture elongation
			8.8 $f_{uk}=800 \text{ N/mm}^2; f_{yk}=640 \text{ N/mm}^2; A_5 > 8\%$ fracture elongation
2	Hexagon nut	Property class acc. to EN ISO 898-2:2012	4 for anchor rod class 4.6 or 4.8
			5 for anchor rod class 5.6 or 5.8
			8 for anchor rod class 8.8
3	Washer, (e.g.: EN ISO 887:2006, EN ISO 7089:2000, EN ISO 7093:2000 oder EN ISO 7094:2000)	Steel, zinc plated, hot-dip galvanised or sherardized	
Stainless steel A2 (Material 1.4301 / 1.4311 / 1.4307 / 1.4567 or 1.4541, acc. to EN 10088-1:2014) and Stainless steel A4 (Material 1.4401 / 1.4404 / 1.4571 / 1.4362 or 1.4578, acc. to EN 10088-1:2014)			
1	Anchor rod ¹⁾	Property class acc. to EN ISO 3506-1:2009	50 $f_{uk}=500 \text{ N/mm}^2; f_{yk}=210 \text{ N/mm}^2; A_5 > 8\%$ fracture elongation
			70 $f_{uk}=700 \text{ N/mm}^2; f_{yk}=450 \text{ N/mm}^2; A_5 > 8\%$ fracture elongation
			80 $f_{uk}=800 \text{ N/mm}^2; f_{yk}=600 \text{ N/mm}^2; A_5 > 8\%$ fracture elongation
2	Hexagon nut ¹⁾	Property class acc. to EN ISO 3506-1:2009	50 for anchor rod class 50
			70 for anchor rod class 70
			80 for anchor rod class 80
3	Washer, (e.g.: EN ISO 887:2006, EN ISO 7089:2000, EN ISO 7093:2000 oder EN ISO 7094:2000)	A2: Material 1.4301, 1.4311 / 1.4307 / 1.4567 or 1.4541, EN 10088-1:2014 A4: Material 1.4401, 1.4404 / 1.4571 / 1.4362 or 1.4578, EN 10088-1:2014	
High corrosion resistance steel (Material 1.4529 or 1.4565, acc. to EN 10088-1: 2014)			
1	Anchor rod	Property class acc. to EN ISO 3506-1:2009	50 $f_{uk}=500 \text{ N/mm}^2; f_{yk}=210 \text{ N/mm}^2; A_5 > 8\%$ fracture elongation
			70 $f_{uk}=700 \text{ N/mm}^2; f_{yk}=450 \text{ N/mm}^2; A_5 > 8\%$ fracture elongation
			80 $f_{uk}=800 \text{ N/mm}^2; f_{yk}=600 \text{ N/mm}^2; A_5 > 8\%$ fracture elongation
2	Hexagon nut	Property class acc. to EN ISO 3506-1:2009	50 for anchor rod class 50
			70 for anchor rod class 70
			80 for anchor rod class 80
3	Washer, (e.g.: EN ISO 887:2006, EN ISO 7089:2000, EN ISO 7093:2000 oder EN ISO 7094:2000)	Material 1.4529 or 1.4565, acc. to EN 10088-1: 2014	
1) Strength class 80 only for stainless steel A4 + high corrosion resistance steel HCR			
Friulsider Injection System for concrete KEM HP, KEM HP Blue, KEM HP Tropical, KEM HP Express		Annex A 4	
Product description Materials			

Specifications of intended use

Anchorage subject to:

- Static and quasi-static loads

Base materials:

- Reinforced or unreinforced normal weight concrete without fibres according to EN 206:2013+A1:2016.
- Strength classes C20/25 to C50/60 according to EN 206:2013+A1:2016.
- Uncracked concrete

Temperature range:

- T1: - 40 °C to +40 °C (max long term temperature +24 °C and max short term temperature +40 °C)
- T2: - 40 °C to +80 °C (max long term temperature +50 °C and max short term temperature +80 °C)

Use conditions (Environmental conditions):

- Structures subject to dry internal conditions (all materials)
- For all other conditions according to EN 1993-1-4:2006+A1:2015 corresponding to corrosion resistance class:
 - Stainless steel class A2 according to Annex A 4, Table A1: CRC II
 - Stainless steel class A4 according to Annex A 4, Table A1: CRC III
 - High corrosion resistance steel HCR according to Annex A 4, Table A1: CRC V

Design:

- Verifiable calculation notes and drawings are prepared taking account of the loads to be anchored. The position of the anchor is indicated on the design drawings (e. g. position of the anchor relative to reinforcement or to supports, etc.).
- Anchorages are designed under the responsibility of an engineer experienced in anchorages and concrete work.
- Anchorages under static or quasi-static actions are designed in accordance with EN 1992-4

Concrete condition:

- I1 – installation in dry or wet (water saturated) concrete and use in service in dry or wet concrete
- I2 – installation in water-filled drill holes (not sea water) and use in service in dry or wet concrete

Installation:

- Hole drilling by hammer or compressed air drill mode.
- Anchor installation carried out by appropriately qualified personnel and under the supervision of the person responsible for technical matters of the site.

Installation direction:

- D3 - Downward and horizontal and upwards (e.g. overhead) installation.

Friulsider Injection System for concrete
KEM HP, KEM HP Blue, KEM HP Tropical, KEM HP Express

Intended use
Specifications

Annex B 1

Table B1: Installation parameters for threaded rod

Anchor size		M 8	M 10	M 12	M 16	M 20	M 24
Nominal drill hole diameter	d_0 [mm] =	10	12	14	18	24	28
Effective anchorage depth	$h_{ef,min}$ [mm] =	60	60	70	80	90	96
	$h_{ef,max}$ [mm] =	160	200	240	320	400	480
Diameter of clearance hole in the fixture	d_f [mm] ≤	9	12	14	18	22	26
Maximum torque moment	T_{inst} [Nm] ≤	10	20	40	80	120	160
Thickness of fixture	$t_{fix,min}$ [mm] >	0					
	$t_{fix,max}$ [mm] <	1500					
Minimum thickness of member	h_{min} [mm]	$h_{ef} + 30$ mm ≥ 100 mm			$h_{ef} + 2d_0$		
Minimum spacing	s_{min} [mm]	40	50	60	80	100	120
Minimum edge distance	c_{min} [mm]	40	50	60	80	100	120

Steel brush SCO

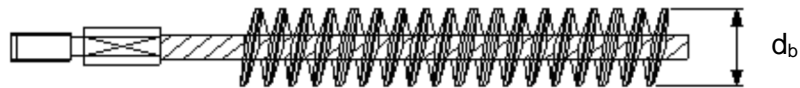

Table B2: Parameter cleaning and setting tools

Threaded Rod	d_0 Drill bit - Ø	d_b Brush - Ø		$d_{b,min}$ min. Brush - Ø
(mm)	(mm)	(mm)		(mm)
M8	10	SCO10	12	10,5
M10	12	SCO12	14	12,5
M12	14	SCO14	16	14,5
M16	18	SCO18	20	18,5
M20	24	SCO24	26	24,5
M24	28	SCO28	30	28,5



Hand pump (volume 750 ml)
Drill bit diameter (d_0): 10 mm to 20 mm
and anchorage depth up to 240 mm



Recommended compressed air tool (min 6 bar)
All applications

Friulsider Injection System for concrete
KEM HP, KEM HP Blue, KEM HP Tropical, KEM HP Express

Intended use
Installation parameters
Cleaning and setting tools

Annex B 2

Installation instructions

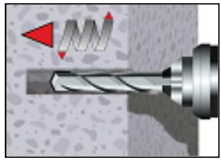

1. Drill with hammer drill a hole into the base material to the size and embedment depth required by the selected anchor (Table B1). In case of aborted drill hole: the drill hole shall be filled with mortar.

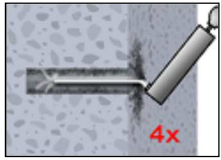

- Attention! Standing water in the bore hole must be removed before cleaning.**
- 2a. Starting from the bottom or back of the bore hole, blow the hole clean with compressed air (min. 6 bar) or a hand pump (Annex B2) a minimum of four times. If the bore hole ground is not reached an extension shall be used.

or

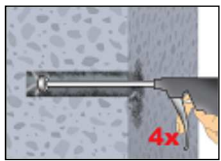

The hand-pump can be used for anchor sizes up to bore hole diameter 20 mm.

For bore holes larger than 20 mm or deeper 240 mm, compressed air (min. 6 bar) **must** be used.

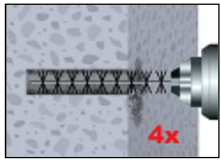

- 2b. Check brush diameter (Table B2) and attach the brush to a drilling machine or a battery screwdriver. Brush the hole with an appropriate sized wire brush $> d_{b,min}$ (Table B2) a minimum of four times. If the bore hole ground is not reached with the brush, a brush extension shall be used (Table B2).

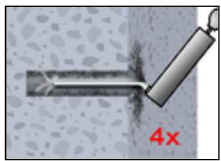

- 2c. Finally blow the hole clean again with compressed air (min. 6 bar) or a hand pump (Annex B2) a minimum of four times. If the bore hole ground is not reached an extension shall be used. The hand-pump can be used for anchor sizes up to bore hole diameter 20 mm. For bore holes larger than 20 mm or deeper 240 mm, compressed air (min. 6 bar) **must** be used.

or

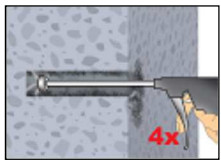

After cleaning, the bore hole has to be protected against re-contamination in an appropriate way, until dispensing the mortar in the bore hole. If necessary, the cleaning repeated has to be directly before dispensing the mortar. In-flowing water must not contaminate the bore hole again

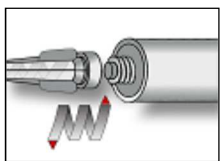

3. Attach a supplied static-mixing nozzle to the cartridge and load the cartridge into the correct dispensing tool. Cut off the foil tube clip before use. For every working interruption longer than the recommended working time (Table B3) as well as for new cartridges, a new static-mixer shall be used.

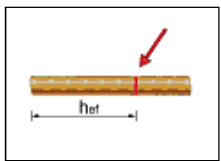

4. Prior to inserting the anchor rod into the filled bore hole, the position of the embedment depth shall be marked on the anchor rods.

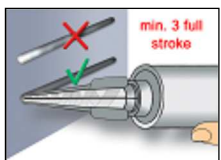

5. Prior to dispensing into the drill hole, squeeze out separately a minimum of three full strokes and discard non-uniformly mixed adhesive components until the mortar shows a consistent grey or blue (KEM HP Blue) colour. For foil tube cartridges it must be discarded a minimum of six full strokes.

Friulside Injection System for concrete
KEM HP, KEM HP Blue, KEM HP Tropical, KEM HP Express

Intended use
 Installation instructions

Annex B 3

Installation instructions (continuation)



6. Starting from the bottom or back of the cleaned anchor hole fill the hole up to approximately two-thirds with adhesive. Slowly withdraw the static mixing nozzle as the hole fills to avoid creating air pockets. If the bottom or back of the anchor hole is not reached, an appropriate extension nozzle must be used. Observe the gel-/ working times given in Table B3.

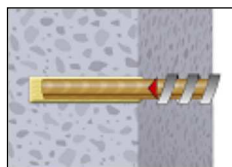

7. Push the threaded rod into the anchor hole while turning slightly to ensure positive distribution of the adhesive until the embedment depth is reached.

The anchor should be free of dirt, grease, oil or other foreign material.

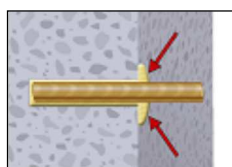

8. Be sure that the anchor is fully seated at the bottom of the hole and that excess mortar is visible at the top of the hole. If these requirements are not maintained, the application has to be renewed. For overhead application the anchor rod should be fixed (e.g. wedges).

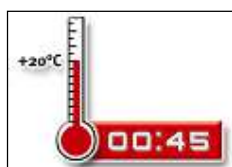

9. Allow the adhesive to cure to the specified time prior to applying any load or torque. Do not move or load the anchor until it is fully cured (attend Table B3).

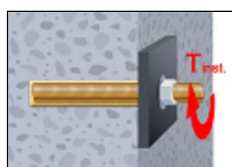

10. After full curing, the add-on part can be installed with the max. torque (Table B1) by using a calibrated torque wrench.

Table B3: Minimum curing time

Concrete temperature	KEM HP Tropical		KEM HP, KEM HP Blue ¹⁾		KEM HP Express	
	Max. working time	Min. curing time	Max. working time	Min. curing time	Max. working time	Min. curing time
-10 to -6 °C					60 min	4 h
-5 to -1 °C			90 min	6 h	45 min	2 h
0 to +4 °C			45 min	3 h	25 min	80 min
+5 to +9 °C			25 min	2 h	10 min	45 min
+10 to +14 °C	30 min	5 h	20 min	100 min	4 min	25 min
+15 to +19 °C	20 min	210 min	15 min	80 min	3 min	20 min
+20 to +29 °C	15 min	145 min	6 min	45 min	2 min	15 min
+30 to +34 °C	10 min	80 min	4 min	25 min		
+35 to +39 °C	6 min	45 min	2 min	20 min		
+40 to +44 °C	4 min	25 min				
+45 °C	2 min	20 min				
Cartridge temperature	+5°C to +45°C		+5°C to +40°C		0°C to +30°C	

¹⁾ The KEM HP Blue injection mortar has a curing time proof by changing the color from blue to gray after curing minimum time. The curing time proof is only valid for the standard version of the mortar.

Friulside Injection System for concrete
KEM HP, KEM HP Blue, KEM HP Tropical, KEM HP Express

Intended use
 Installation instructions (continuation)
 Curing time

Annex B 4

Table C1: Characteristic values for steel tension resistance and steel shear resistance of threaded rods

Size			M 8	M 10	M 12	M 16	M 20	M 24	
Cross section area	A _s	[mm ²]	36,6	58	84,3	157	245	353	
Characteristic tension resistance, Steel failure ¹⁾									
Steel, Property class 4.6 and 4.8	N _{Rk,s}	[kN]	15 (13)	23 (21)	34	63	98	141	
Steel, Property class 5.6 and 5.8	N _{Rk,s}	[kN]	18 (17)	29 (27)	42	78	122	176	
Steel, Property class 8.8	N _{Rk,s}	[kN]	29 (27)	46 (43)	67	125	196	282	
Stainless steel A2, A4 and HCR, Property class 50	N _{Rk,s}	[kN]	18	29	42	79	123	177	
Stainless steel A2, A4 and HCR, Property class 70	N _{Rk,s}	[kN]	26	41	59	110	171	247	
Stainless steel A4 and HCR, Property class 80	N _{Rk,s}	[kN]	29	46	67	126	196	282	
Characteristic tension resistance, Partial safety factor ²⁾									
Steel, Property class 4.6	γ _{Ms,N}	[-]	2,0						
Steel, Property class 4.8	γ _{Ms,N}	[-]	1,5						
Steel, Property class 5.6	γ _{Ms,N}	[-]	2,0						
Steel, Property class 5.8	γ _{Ms,N}	[-]	1,5						
Steel, Property class 8.8	γ _{Ms,N}	[-]	1,5						
Stainless steel A2, A4 and HCR, Property class 50	γ _{Ms,N}	[-]	2,86						
Stainless steel A2, A4 and HCR, Property class 70	γ _{Ms,N}	[-]	1,87						
Stainless steel A4 and HCR, Property class 80	γ _{Ms,N}	[-]	1,6						
Characteristic shear resistance, Steel failure ¹⁾									
Without lever arm	Steel, Property class 4.6 and 4.8	V ⁰ _{Rk,s}	[kN]	9 (8)	14 (13)	20	38	59	85
	Steel, Property class 5.6 and 5.8	V ⁰ _{Rk,s}	[kN]	9 (8)	15 (13)	21	39	61	88
	Steel, Property class 8.8	V ⁰ _{Rk,s}	[kN]	15 (13)	23 (21)	34	63	98	141
	Stainless steel A2, A4 and HCR, Property class 50	V ⁰ _{Rk,s}	[kN]	9	15	21	39	61	88
	Stainless steel A2, A4 and HCR, Property class 70	V ⁰ _{Rk,s}	[kN]	13	20	30	55	86	124
	Stainless steel A4 and HCR, Property class 80	V ⁰ _{Rk,s}	[kN]	15	23	34	63	98	141
With lever arm	Steel, Property class 4.6 and 4.8	M ⁰ _{Rk,s}	[Nm]	15 (13)	30 (27)	52	133	260	449
	Steel, Property class 5.6 and 5.8	M ⁰ _{Rk,s}	[Nm]	19 (16)	37 (33)	65	166	324	560
	Steel, Property class 8.8	M ⁰ _{Rk,s}	[Nm]	30 (26)	60 (53)	105	266	519	896
	Stainless steel A2, A4 and HCR, Property class 50	M ⁰ _{Rk,s}	[Nm]	19	37	66	167	325	561
	Stainless steel A2, A4 and HCR, Property class 70	M ⁰ _{Rk,s}	[Nm]	26	52	92	232	454	784
	Stainless steel A4 and HCR, Property class 80	M ⁰ _{Rk,s}	[Nm]	30	59	105	266	519	896
Characteristic shear resistance, Partial safety factor ²⁾									
Steel, Property class 4.6	γ _{Ms,V}	[-]	1,67						
Steel, Property class 4.8	γ _{Ms,V}	[-]	1,25						
Steel, Property class 5.6	γ _{Ms,V}	[-]	1,67						
Steel, Property class 5.8	γ _{Ms,V}	[-]	1,25						
Steel, Property class 8.8	γ _{Ms,V}	[-]	1,25						
Stainless steel A2, A4 and HCR, Property class 50	γ _{Ms,V}	[-]	2,38						
Stainless steel A2, A4 and HCR, Property class 50 70	γ _{Ms,V}	[-]	1,56						
Stainless steel A4 and HCR, Property class 80	γ _{Ms,V}	[-]	1,33						
¹⁾ Values are only valid for the given stress area A _s . Values in brackets are valid for undersized threaded rods with smaller stress area A _s for hot dipped threaded rods galvanized according to EN ISO 10684:2004+AC:2009. ²⁾ in absence of national regulation									
Friulsider Injection System for concrete KEM HP, KEM HP Blue, KEM HP Tropical, KEM HP Express							Annex C 1		
Performances Characteristic values for steel tension resistance and steel shear resistance of threaded rods									

Table C2: Characteristic values under tension loads in uncracked concrete

Anchor size threaded rod				M 8	M 10	M 12	M 16	M 20	M 24
Steel failure									
Characteristic tension resistance	$N_{Rk,s}$	[kN]	$A_s \cdot f_{uk}$ (or see Table C1)						
Partial factor	$\gamma_{Ms,N}$	[-]	see Table C1						
Combined pull-out and concrete cone failure									
Characteristic bond resistance in uncracked concrete C20/25									
Temperature range I: 40°C/24°C	dry and wet concrete	$\tau_{Rk,ucr}$	[N/mm ²]	8,5	8,0	8,0	8,0	8,0	8,0
	flooded bore hole	$\tau_{Rk,ucr}$	[N/mm ²]	8,5	8,0	8,0	8,0	8,0	8,0
Temperature range II: 80°C/50°C	dry and wet concrete	$\tau_{Rk,ucr}$	[N/mm ²]	6,5	6,0	6,0	6,0	6,0	6,0
	flooded bore hole	$\tau_{Rk,ucr}$	[N/mm ²]	6,5	6,0	6,0	6,0	6,0	6,0
Increasing factors for concrete ψ_c		C25/30		1,04					
		C30/37		1,08					
		C35/45		1,13					
		C40/50		1,15					
		C45/55		1,17					
		C50/60		1,19					
Concrete cone failure									
Factor	$k_{ucr,N}$	[-]	11,0						
Edge distance	$c_{cr,N}$	[mm]	$1,5 h_{ef}$						
Axial distance	$s_{cr,N}$	[mm]	$2 c_{cr,N}$						
Splitting failure									
Edge distance	$h/h_{ef} \geq 2,0$	$c_{cr,sp}$	[mm]	$1,0 h_{ef}$					
	$2,0 > h/h_{ef} > 1,3$			$2 \cdot h_{ef} \left(2,5 - \frac{h}{h_{ef}} \right)$					
	$h/h_{ef} \leq 1,3$			$2,4 h_{ef}$					
Axial distance	$s_{cr,sp}$	[mm]	$2 c_{cr,sp}$						
Installation factor									
for dry and wet concrete	γ_{inst}	[-]	1,2						
for flooded bore hole	γ_{inst}	[-]	1,2						
Friulsider Injection System for concrete KEM HP, KEM HP Blue, KEM HP Tropical, KEM HP Express								Annex C 2	
Performances Characteristic values under tension loads in uncracked concrete									

Table C3: Characteristic values under shear loads in uncracked concrete

Anchor size threaded rod		M 8	M 10	M 12	M 16	M 20	M 24	
Steel failure without lever arm								
Characteristic shear resistance Steel, strength class 4.6 and 4.8	$V_{Rk,s}^0$	[kN]	$0,6 \cdot A_s \cdot f_{uk}$ (or see Table C1)					
Characteristic shear resistance Steel, strength class 5.6, 5.8 and 8.8 Stainless Steel A2, A4 and HCR, all classes	$V_{Rk,s}^0$	[kN]	$0,5 \cdot A_s \cdot f_{uk}$ (or see Table C1)					
Partial factor	$\gamma_{Ms,V}$	[-]	see Table C1					
Ductility factor	k_7	[-]	1,0					
Steel failure with lever arm								
Characteristic bending moment	$M_{Rk,s}^0$	[Nm]	$1,2 \cdot W_{el} \cdot f_{uk}$ (or see Table C1)					
Partial factor	$\gamma_{Ms,V}$	[-]	see Table C1					
Concrete pry-out failure								
Factor	k_8	[-]	2,0					
Installation factor	γ_{inst}	[-]	1,0					
Concrete edge failure								
Effective length of fastener	l_f	[mm]	$l_f = \min(h_{ef}; 12 d_{nom})$					
Outside diameter of fastener	d_{nom}	[mm]	8	10	12	16	20	24
Installation factor	γ_{inst}	[-]	1,0					
Friulsider Injection System for concrete KEM HP, KEM HP Blue, KEM HP Tropical, KEM HP Express							Annex C 3	
Performances Characteristic values under shear loads in uncracked concrete								

Table C4: Displacement under tension load¹⁾

Anchor size threaded rod		M 8	M 10	M 12	M 16	M 20	M 24	
Uncracked concrete C20/25								
Temperature range I: 40°C/24°C	δ_{N0} -factor	[mm/(N/mm ²)]	0,03	0,04	0,05	0,07	0,08	0,10
	$\delta_{N\infty}$ -factor	[mm/(N/mm ²)]	0,07	0,08	0,08	0,08	0,08	0,10
Temperature range II: 80°C/50°C	δ_{N0} -factor	[mm/(N/mm ²)]	0,02	0,03	0,03	0,04	0,04	0,05
	$\delta_{N\infty}$ -factor	[mm/(N/mm ²)]	0,15	0,17	0,17	0,17	0,17	0,17

¹⁾ Calculation of the displacement

$$\delta_{N0} = \delta_{N0\text{-factor}} \cdot \tau;$$

$$\delta_{N\infty} = \delta_{N\infty\text{-factor}} \cdot \tau;$$

Table C5: Displacement under shear load¹⁾

Anchor size threaded rod		M 8	M 10	M 12	M 16	M 20	M 24	
For uncracked concrete C20/25								
All temperature ranges	δ_{V0} -factor	[mm/kN]	0,02	0,02	0,01	0,01	0,01	0,01
	$\delta_{V\infty}$ -factor	[mm/kN]	0,03	0,02	0,02	0,01	0,01	0,01

¹⁾ Calculation of the displacement

$$\delta_{V0} = \delta_{V0\text{-factor}} \cdot V;$$

$$\delta_{V\infty} = \delta_{V\infty\text{-factor}} \cdot V;$$

**Friulsider Injection System for concrete
KEM HP, KEM HP Blue, KEM HP Tropical, KEM HP Express**

Performances
Displacement

Annex C 4